

PENDANT LIGHT

IPL570A01
10/14

QUESTIONS OR CONCERNS CONTACT CANARM AT:
1-800-265-1833 (English) 1-800-567-2513 (French)
Monday through Friday 8:00 AM to 5:00 PM E.S.T.



INSTRUCTIONS PERTAINING TO RISK OF FIRE OR INJURY TO PERSONS
READ ALL INSTRUCTIONS

IMPORTANT SAFETY INSTRUCTIONS

SAVE THESE INSTRUCTIONS

TOOLS AND MATERIALS REQUIRED:



Phillips Screwdriver



Wire Cutters



Pliers



Wrench

Wiring supplies as required by the Canadian Electrical Code and/or the Quebec Electrical code

SAFETY PRECAUTIONS:

1. TURN OFF ELECTRICAL POWER BEFORE STARTING INSTALLATION OF LIGHT FIXTURE.
2. THIS PRODUCT MUST BE INSTALLED IN ACCORDANCE WITH THE APPLICABLE INSTALLATION CODE BY A PERSON FAMILIAR WITH THE CONSTRUCTION AND OPERATION OF THE PRODUCT AND THE HAZARDS INVOLVED.
3. FIRMLY ATTACH THE FIXTURE GROUND WIRE (BARE COPPER) TO THE MOUNTING BRACKET WITH THE GROUND SCREW (BY WRAPPING AROUND THE GROUND SCREW) AND THEN CONNECT IT TO THE HOUSE SUPPLY GROUND WIRE WITH A WIRE NUT.

NOTE: Product May Not Look Exactly As Shown In Figures.

INSTALLATION:

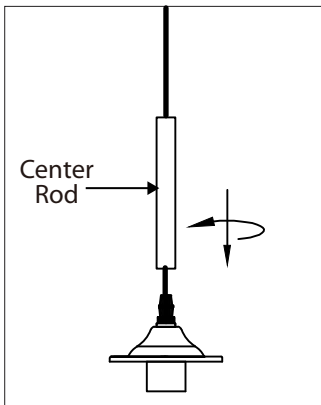

1. Secure the center rod to the fixture socket.

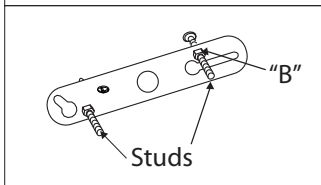

2. Loosen "B". Adjust stud to desired length and lock in place with "B"

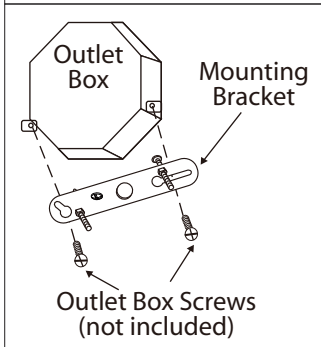

3. Mount the mounting bracket to outlet box using outlet box screws (not included). Make sure the studs on the mounting bracket are facing out from the outlet box.

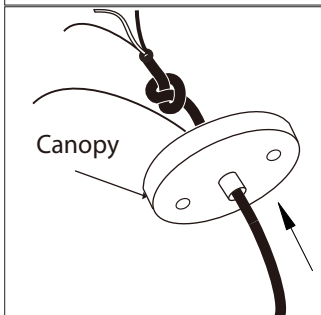

4. Adjusting the length of flexible cord. For safety, do not release the knot inside canopy.

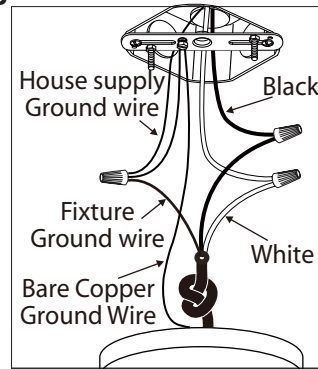

5. Firmly attach the fixture ground wire (bare copper) to the mounting bracket with the ground screw (by wrapping around the ground screw) and then connect it to the house supply ground wire with a wire nut. Connect the black wire (or wire with marking) from the fixture to the black wire in the electrical box and connect the white wire from the fixture to the white wire in the electrical box.

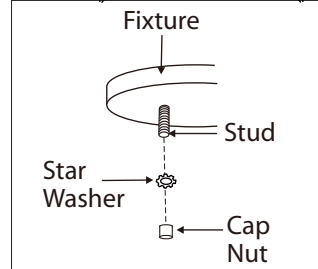

6. Once connections of wires are completed, carefully tuck wires and wire nuts into the outlet box making sure no bare wire (on the black and white) is visible at the wire nuts.

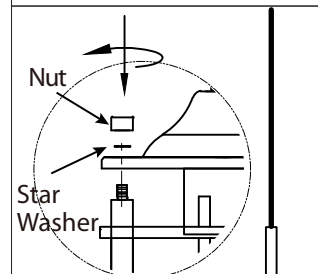

7. Position fixture over studs on mounting bracket assembly. Secure fixture in place with star washer(s) and cap nut(s).

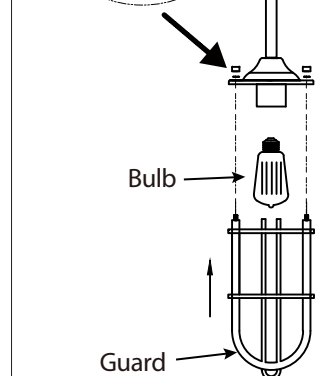

8. Install specified bulb type and wattage.

9. Install the guard with star washers and nuts.