

QUESTIONS OR CONCERNS, CONTACT CANARM AT:

1-800-265-1833 (English) 1-800-567-2513 (French) Monday through Friday 8:00 AM to 5:00 PM E.S.T.



INSTRUCTIONS PERTAINING TO RISK OF FIRE OR INJURY TO PERSONS
READ ALL INSTRUCTIONS

IMPORTANT SAFETY INSTRUCTIONS SAVE THESE INSTRUCTIONS

TOOLS AND MATERIALS REQUIRED:



Star-headed
Screwdriver



Pliers



Hammer



Wiring supplies
as required by
electrical code

SAFETY PRECAUTIONS:

1. TURN OFF ELECTRICAL POWER BEFORE STARTING INSTALLATION OF LIGHT FIXTURE.
2. THIS PRODUCT MUST BE INSTALLED IN ACCORDANCE WITH THE APPLICABLE INSTALLATION CODE BY A PERSON FAMILIAR WITH THE CONSTRUCTION AND OPERATION OF THE PRODUCT AND THE HAZARDS INVOLVED.
3. THIS FIXTURE IS DESIGNED FOR 120 VOLT CIRCUIT. IF UNSURE ABOUT WIRING, CONSULT AN ELECTRICIAN.
WARNING: DO NOT CONNECT FIXTURE TO DIMMER CIRCUIT.

4. THIS FIXTURE MUST BE GROUNDED PROPERLY. CONNECT THE GROUND WIRE (BARE COPPER OR GREEN) TO THE AC SUPPLY GROUND WIRE (BARE COPPER OR GREEN) OR GROUND SCREW IN THE ELECTRICAL OUTLET BOX. IF GROUND WIRE IS NOT AVAILABLE IN YOUR AC SUPPLY WIRE SYSTEM, PLEASE CONSULT A QUALIFIED ELECTRICIAN BEFORE PROCEEDING THE ELECTRICAL CONNECTION.

5. USE ONLY ENERGY STAR APPROVED BALLAST (WITH LAMP SOCKETS) MANUFACTURED BY CSA FILE NUMBER 226237 AND MARKETED BY CANARM LIMITED. THIS BALLAST IS REPLACEABLE BY A QUALIFIED ELECTRICIAN WITHOUT CUTTING OF THE WIRES.

INSTALLATION:

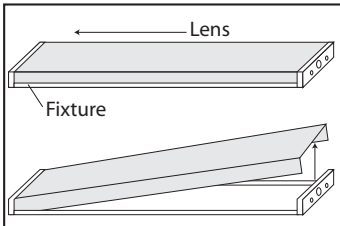

1. Remove the Acrylic Lens and place aside to avoid possible damage. Slide the lens towards one end of the fixture. Gently press down the end of the lens that is away from the housing. (Be careful not to crack the lens.) This will release the lens from the retaining clip. Lift up this end and pull the lens away from the fixture.

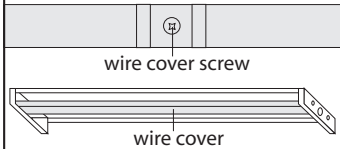

2. Remove the wire cover screw. Using both hands, squeeze the wire cover at both ends to release from the housing and gently pull it away.

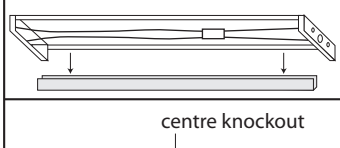

3. Turn the fixture over and locate the center knockout. Make sure the fixture is supported on the underside and break part of the knockout away using a hammer and screw driver. Twist out the knockout using pliers.

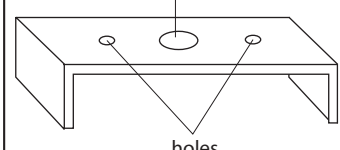

4. Position the housing on the ceiling with the center knockout over the electrical box. Mark the ceiling for the pilot hole locations through the small holes on either end. Drill 1/8" pilot holes at each location. Determine the appropriate way of fastening the fixture to the ceiling (wood screws or toggle bolts, not included).

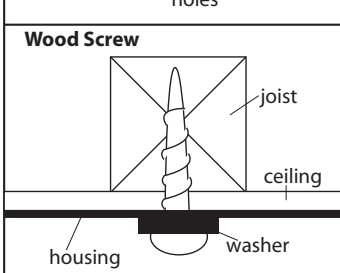

Note: Toggle bolts will require a larger pilot hole. Secure the fixture to the ceiling using the appropriate fasteners. Connect the ground wire to the ground screw located near the center knockout. Connect the black wire from the fixture to the black wire from the electrical box. Connect the white wire from the fixture to the white wire from the electrical box. Once wires are connected, carefully tuck wires and marretts into the metal outlet box.

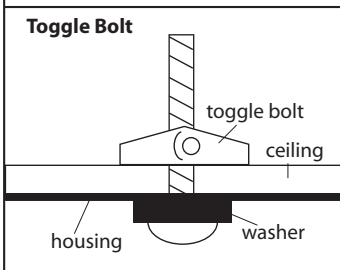

5. Alternatively, if an outlet (electrical) box is not available, if the fixture doesn't cover the outlet (electrical) box entirely or if the electrical leads are coming from either end of the fixture, please consult a qualified electrician for Armour Cable or Conduit Electrical Feed type of installation.

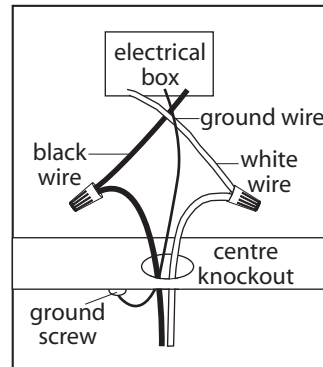

6. Replace the wire cover by reversing the process of Step #2.

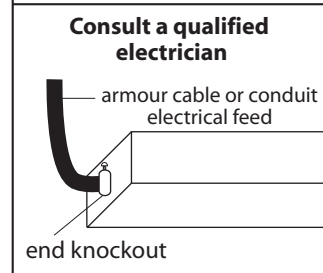

7. Install proper bulb type and wattage. Insert the pins on both ends of the fluorescent tube into the lamp holders on both ends. Rotate the tube until a slight "click" is felt. Repeat for additional bulbs.

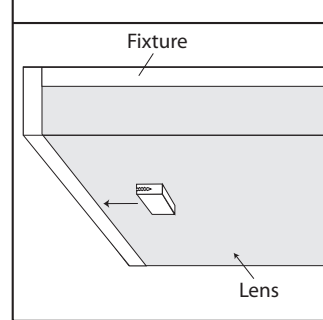

8. Replace the lens by reversing the process of Step #1.

9. Insert the safety clip as shown in both ends to avoid possible falling of lens.

10. When the ballast is replaced, reverse the process from step 9 to 5. Loosen the screw and nut to remove the ballast and sockets from fixture. After that repeat the normal process from step 5 to 9.