

Pablo®

ELISE

INFO@PABLODESIGNS.COM  
888 MARIN STREET  
SAN FRANCISCO, CA  
94124

PABLODESIGNS.COM

Pablo®

ELISE

32, 48, 60, 80 ASSEMBLY & INSTALLATION INSTRUCTIONS



APPROVED COMPONENTS

# Pablo® ELISE

## ELISE MODELS



ELISE 80



ELISE 60



ELISE 48



ELISE 32

## BULB TYPE

ELISE 32, 48, 60: E26 / 75W-PAR30 NSP  
ELISE 80: E26 / 90W-PAR38 NSP



## CARE INSTRUCTIONS

WIPE CLEAN WITH A SOFT DAMP CLOTH.  
AVOID AMMONIA-BASED CLEANERS.

## ASSEMBLY

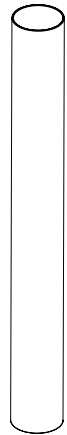

1

REMOVE SHADE AND BULB FROM BASE

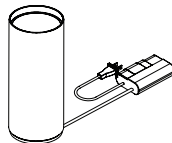

NOTE: ELISE 80 BASE AND SHADE  
SHIP SEPARATELY.

# Pablo® ELISE

## ASSEMBLY

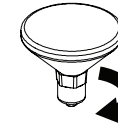

2

UNWRAP BULB AND SCREW INTO SOCKET

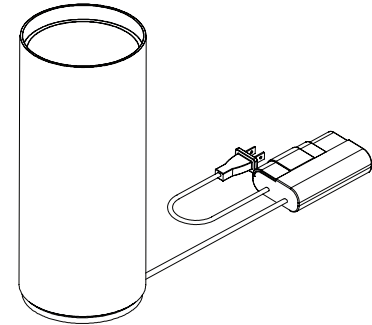

## ASSEMBLY



3

INSERT SHADE INTO BASE WITH  
LOGO SIDE DOWN.

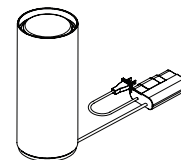

Pablo®

ELISE

INFO@PABLODESIGNS.COM  
888 MARIN STREET  
SAN FRANCISCO, CA  
94124

PABLODESIGNS.COM

Pablo®

ELISE

12 & 18 ASSEMBLY & INSTALLATION INSTRUCTIONS



APPROVED COMPONENTS

# Pablo® ELISE

## ELISE MODELS



ELISE 12

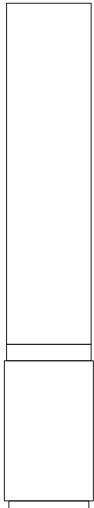

ELISE 18

## BULB TYPE

ELISE 12 : E14 / 25W - TORPEDO FROSTED WHITE  
ELISE 18 : E26 / 40W - T-10 FROSTED WHITE

## CARE INSTRUCTIONS

WIPE CLEAN WITH A SOFT DAMP CLOTH.  
AVOID AMMONIA-BASED CLEANERS.

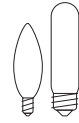

## ASSEMBLY

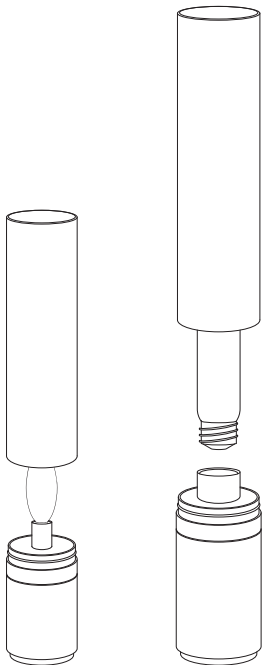

**1** REMOVE SHADE AND BULB FROM BASE

## ASSEMBLY

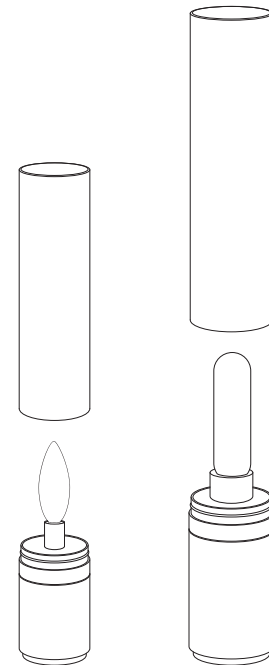

**3** INSERT SHADE INTO BASE WITH LOGO SIDE DOWN.

## ASSEMBLY

**2** UNWRAP BULB AND SCREW INTO SOCKET

