

Pablo®

CORTINA

24, 48, 60, 72 ASSEMBLY & INSTALLATION INSTRUCTIONS



APPROVED COMPONENTS

Pablo®

CORTINA

CORTINA MODELS

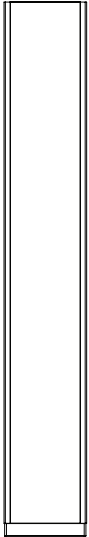

CORTINA 72



CORTINA 60

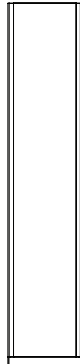

CORTINA 48

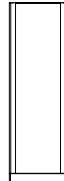

CORTINA 24

BULB TYPE

CORTINA 24, 48, 60: 2X E27 / 60W-PAR16 NSP
CORTINA 72: 2X E27 / 75W-PAR16 NSP



CARE INSTRUCTIONS

WIPE CLEAN WITH A SOFT DAMP CLOTH.
AVOID AMMONIA-BASED CLEANERS.

ASSEMBLY

- 1 REMOVE PARTS FROM PACKAGING.
BULBS ARE LOCATED INSIDE SHADE

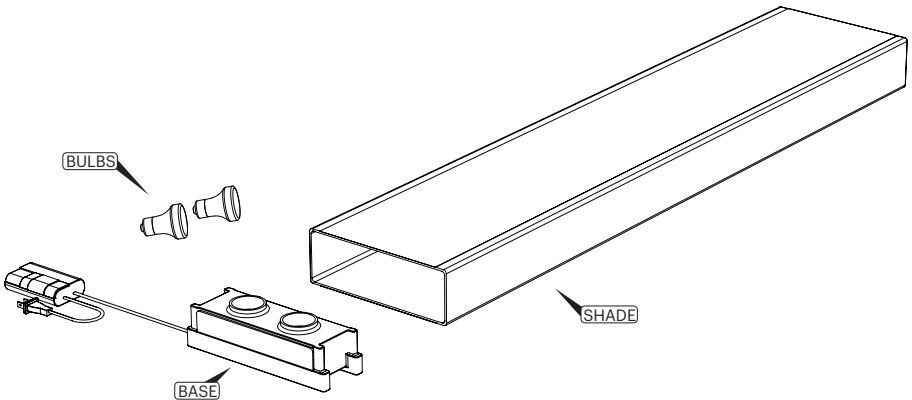

Pablo®

CORTINA

ASSEMBLY

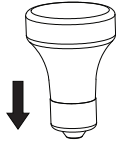

2 SCREW BULBS INTO SOCKETS

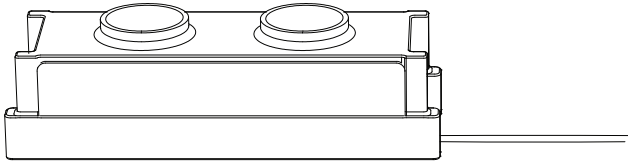

ASSEMBLY

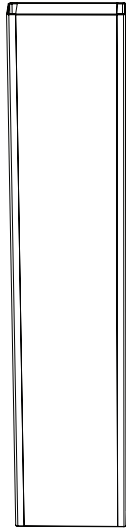

3 PRESS FIT SHADE OVER BASE AS SHOWN

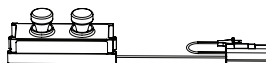

Pablo®

CORTINA

INFO@PABLODESIGNS.COM
888 MARIN STREET
SAN FRANCISCO, CA
94124

PABLODESIGNS.COM