

Type \_\_\_\_\_  
 -28 -31  
 P6280

Catalog No.	Finish		Lamping	Dimensions (Inches)	
	White	Black		A	B
P6280	-28	-31	Any (m) PAR, R, BR (Except short neck PAR)	2	4-7/8

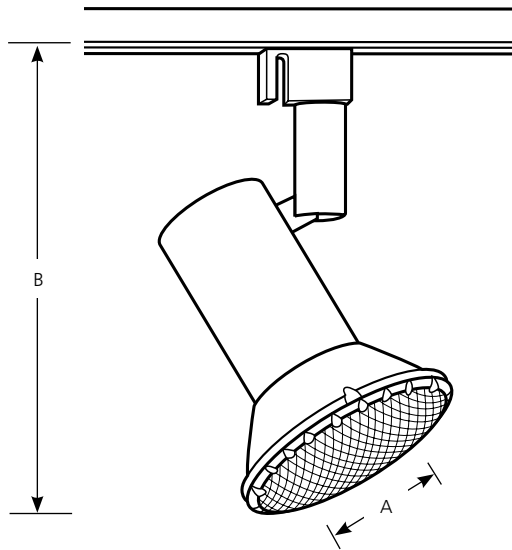

**Specifications:**

Track Lock up

- For use with Alpha (P9100 series) track
- Polarity oriented
- Quarter-turn locking action
- Tab lock to track to prevent accidental removal

Track Head Support

- Single stem, friction lock
- 360 degree rotation
- 0 to 90 degree vertical swing

Track Head

- Steel construction
- White (-28) or Black (-31) finishes
- Porcelain socket with nickel plated brass screw shell

Labeling

- UL-CUL listed

Photometrics

- Refer to Lamp Application Data for:
  - R20, PAR20 & PAR16
  - BR30 & PAR30
  - PAR38 & BR40

## R20, PAR16 and PAR20 Lamp Application Data

Figure 1  
Single lampholder

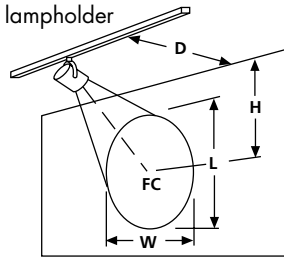
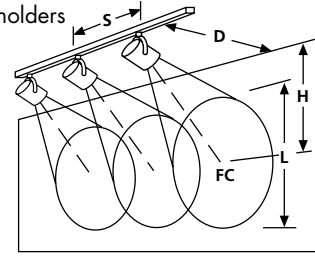

Figure 2  
Multiple lampholders



R20 Flood Lamps



	Walls and Vertical Objects												Horizontal Surfaces			
	H	F.C.	L	W	S	F.C.	L	W	S	F.C.	L	W	S	Clg. Ht.	F.C.	Dia. & Spacing
	D = 2 FT				D = 3 FT				D = 4 FT							
30R20FL	2	27	2.3	1.5	1.4	19	2.4	1.9	1.8	13	2.7	2.4	2.2	8	10	2.8
CBCP - 300	3	13	4.2	1.9	1.8	12	3.5	2.3	2.1	10	3.5	2.7	2.4	9	7	3.4
Beam - 30 deg.	4	7	7.5	2.4	2.2	7	5.1	2.7	2.4	7	4.6	3.0	2.8	10	5	3.9
50R20FL	2	47	4.0	2.3	1.9	35	3.9	3.0	2.5	25	4.3	3.7	3.1	8	18	4.2
CBCP - 550	3	23	8.8	3.0	2.5	22	6.0	3.5	2.9	18	5.7	4.1	3.4	9	13	5
Beam - 45 deg.	4	12	26.2	3.7	3.1	13	9.9	4.1	3.4	12	8.0	4.7	3.9	10	10	5.7
P75R20	2	57	4.0	2.3	1.9	42	3.9	3.0	2.5	29	4.3	3.7	3.1	8	21	4.2
CBCP - 650	3	28	8.8	3.0	2.5	26	6.0	3.5	2.9	21	5.7	4.1	3.4	9	15	5.0
Beam - 45 deg.	4	15	26.2	3.7	3.1	16	9.9	4.1	3.4	14	8.0	4.7	3.9	10	12	5.7

PAR16 & PAR20 Flood Lamps



PAR16



PAR20

	Walls and Vertical Objects												Horizontal Surfaces			
	H	F.C.	L	W	S	F.C.	L	W	S	F.C.	L	W	S	Clg. Ht.	F.C.	Dia. & Spacing
	D = 2 FT				D = 3 FT				D = 4 FT							
45PAR16NFL	2	124	2.0	1.4	1.3	90	2.1	1.7	1.6	63	2.4	2.1	2.0	8	46	2.6
CBCP - 1,400	3	60	3.6	1.7	1.6	55	3.1	2.0	1.9	45	3.1	2.4	2.2	9	33	3.0
Beam - 27 deg.	4	31	6.2	2.1	2.0	34	4.5	2.4	2.2	31	4.1	2.7	2.5	10	25	3.5
50PAR20NFL	3	60	4.2	1.9	1.8	55	3.5	2.3	2.1	45	3.5	2.7	2.4	8	46	2.8
CBCP - 1,400	4	31	7.5	2.4	2.2	34	5.1	2.7	2.4	31	4.6	3.0	2.8	9	33	3.4
Beam - 30 deg.	5	18	14.1	2.9	2.6	21	7.6	3.1	2.8	21	6.2	3.4	3.1	10	25	3.9
60/75PAR16NFL	3	85	3.6	1.7	1.6	79	3.1	2.0	1.9	64	3.1	2.4	2.2	8	66	2.6
CBCP - 2,000	4	45	6.2	2.1	2.0	48	4.5	2.4	2.2	44	4.1	2.7	2.7	9	48	3.0
Beam - 27 deg.	5	29	10.9	2.6	2.4	30	6.5	2.8	2.6	31	5.4	3.1	3.1	10	36	3.5

PAR16 & PAR20 Spot Lamps



PAR16



PAR20

	Walls and Vertical Objects												Horizontal Surfaces			
	H	F.C.	L	W	S	F.C.	L	W	S	F.C.	L	W	S	Clg. Ht.	F.C.	Dia. & Spacing
	D = 2 FT				D = 3 FT				D = 4 FT							
45PAR16NSP	4	112	1.8	0.8	0.8	120	1.5	0.9	0.9	110	1.4	1.0	1.0	8	89	1.3
CBCP - 5,000	5	64	2.7	0.9	0.9	76	2.0	1.0	1.0	76	1.8	1.1	1.1	10	55	1.7
Beam - 10 deg.	6	39	3.8	1.1	1.1	50	2.7	1.2	1.2	53	2.3	1.3	1.2	12	38	2.0
50PAR20NSP	4	149	1.3	0.8	0.8	137	1.3	0.9	0.9	118	1.3	1.0	1.0	10	110	1.2
CBCP - 6,200	6	62	2.4	1.1	1.0	66	2.1	1.1	1.1	73	1.8	1.2	1.2	12	69	1.5
Beam - 9 deg.	8	30	4.0	1.3	1.3	35	3.2	1.4	1.4	37	2.8	1.5	1.5	14	48	1.8
60/75PAR16NSP	4	180	1.5	0.9	0.9	166	1.4	1.0	1.0	143	1.4	1.1	1.1	10	133	1.3
CBCP - 7,500	6	75	2.7	1.2	1.2	80	2.3	1.3	1.2	89	2.0	1.3	1.3	12	83	1.7
Beam - 10 deg.	8	36	4.5	1.5	1.5	42	3.6	1.6	1.5	45	3.2	1.7	1.6	14	57	2.0

Walls and Vertical Objects

H	Height from ceiling to center of beam
D	Distance from fixture to wall
F.C.	Footcandles at center of beam
L	Length of effective lighted area
W	Width of effective lighted area
S	Spacing of multiple fixtures to effectively light wall

Horizontal Surfaces

Clg. Ht.	Height from floor to ceiling
F.C.	Footcandles 30" from floor (work plane)
Dia. & Spacing	Diameter of effective lighted area and spacing to effectively light the horizontal surface

CBCP - Center Beam Candlepower

**BR30 and PAR30 Lamp Application Data**

Figure 1  
Single lampholder

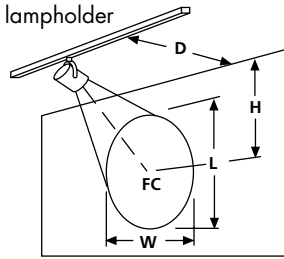
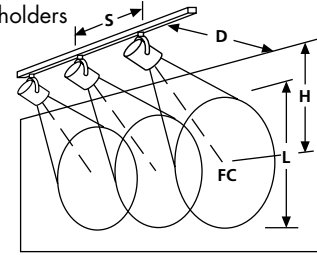

Figure 2  
Multiple lampholders



BR30 Flood Lamp



BR30 Spot Lamp



PAR30  
Flood Lamps



PAR30  
Spot Lamps



Walls and Vertical Objects														Horizontal Surfaces		
H	F.C.	L	W	S	F.C.	L	W	S	F.C.	L	W	S	Clg. Ht.	F.C.	Dia. & Spacing	
D = 2 FT				D = 3 FT				D = 4 FT								
65BR30FL	2	46	5.7	2.9	2.3	34	5.1	3.8	2.9	23	5.6	4.7	3.6	8	17	5.1
CBCP - 525	3	22	17.3	3.8	2.9	21	8.6	4.4	3.4	17	12.0	5.2	4.0	9	12	6
Beam - 55 deg.	4	12	*	4.7	3.6	13	16.7	5.2	4.0	11	11.4	5.9	4.5	10	9	6.9
Walls and Vertical Objects														Horizontal Surfaces		
H	F.C.	L	W	S	F.C.	L	W	S	F.C.	L	W	S	Clg. Ht.	F.C.	Dia. & Spacing	
D = 2 FT				D = 3 FT				D = 4 FT								
65BR30SP	3	69	2.5	1.3	1.2	64	2.2	1.5	1.4	52	2.2	1.8	1.7	8	54	1.9
CBCP - 1625	4	36	4.0	1.6	1.5	39	3.1	1.8	1.7	36	2.9	2.0	1.9	9	38	2.3
Beam - 20 deg.	5	21	6.3	1.9	1.8	25	4.4	2.1	2.0	25	3.8	2.3	2.2	10	29	2.6
Walls and Vertical Objects														Horizontal Surfaces		
H	F.C.	L	W	S	F.C.	L	W	S	F.C.	L	W	S	Clg. Ht.	F.C.	Dia. & Spacing	
D = 2 FT				D = 3 FT				D = 4 FT								
50PAR30/HIR/FL	3	64	5.3	2.3	2.0	59	4.2	2.7	2.4	48	4.2	3.2	2.8	8	50	3.3
CBCP - 1500	4	34	10.4	2.8	2.5	36	6.4	3.2	2.8	33	5.6	3.6	3.1	9	36	3.9
Beam - 35 deg.	5	19	24.2	3.4	3.0	23	9.9	3.7	3.2	23	7.6	4.0	3.6	10	27	4.5
50PAR30FL	3	60	5.3	2.3	2.0	55	4.2	2.7	2.4	45	4.2	3.2	2.8	8	46	3.3
CBCP - 1400	4	31	10.4	2.8	2.5	34	6.4	3.2	2.8	31	5.6	3.6	3.1	9	33	3.9
Beam - 35 deg.	5	18	24.2	3.4	3.0	21	9.9	3.7	3.2	21	7.6	4.0	3.6	10	25	4.5
75PAR30FL	3	85	5.8	2.4	2.1	79	4.5	2.8	2.5	64	4.5	3.3	2.9	8	66	3.5
CBCP - 2000	4	45	12.1	3.0	2.6	48	6.9	3.3	2.9	44	6.0	3.8	3.3	9	47	4.1
Beam - 35 deg.	5	26	32.3	3.6	3.1	30	11.0	3.9	3.4	31	8.3	4.3	3.7	10	36	4.8
75PAR30FL-L	3	133	3.2	1.6	1.5	122	2.8	1.9	1.8	90	2.9	2.2	2.1	8	102	2.4
CBCP - 3100	4	70	5.5	2.0	1.9	74	4.0	2.2	2.1	68	3.7	2.5	2.3	9	74	2.8
Beam - 25 deg.	5	40	9.3	2.4	2.2	47	5.8	2.6	2.4	40	4.9	2.8	2.7	10	55	3.2
Walls and Vertical Objects														Horizontal Surfaces		
H	F.C.	L	W	S	F.C.	L	W	S	F.C.	L	W	S	Clg. Ht.	F.C.	Dia. & Spacing	
D = 3 FT				D = 4 FT				D = 5 FT								
50PAR30/HIR/NSP	4	313	1.3	0.8	0.8	287	1.3	0.9	0.9	247	1.3	1.0	1.0	12	144	1.5
CBCP - 13,000	6	130	2.4	1.1	1.0	139	2.1	1.1	1.1	154	1.8	1.2	1.2	16	71	2.1
Beam - 9 deg.	8	63	4.0	1.3	1.3	73	3.2	1.4	1.4	77	2.8	1.5	1.5	20	42	2.7
50PAR20NSP	4	166	1.5	0.9	0.9	152	1.4	1.0	1.0	131	1.4	1.1	1.1	10	123	1.3
CBCP - 6,900	6	69	2.7	1.2	1.2	74	2.3	1.3	1.2	81	2.0	1.3	1.3	12	76	1.7
Beam - 10 deg.	8	33	4.5	1.5	1.5	39	3.6	1.6	1.5	41	3.2	1.7	1.6	14	52	2.0
75PAR30NSP	4	313	1.5	0.9	0.9	287	1.4	1.0	1.0	247	1.4	1.1	1.1	10	231	1.3
CBCP - 13,000	6	130	2.7	1.2	1.2	139	2.3	1.3	1.2	154	2.0	1.3	1.3	14	98	2.0
Beam - 10 deg.	8	63	4.5	1.5	1.5	73	3.6	1.6	1.5	77	3.2	1.7	1.6	18	54	2.7
75PAR30NSP-L	4	217	1.5	0.9	0.9	199	1.4	1.0	1.0	171	1.4	1.1	1.1	10	160	1.3
CBCP - 9,000	6	90	2.7	1.2	1.2	96	2.3	1.3	1.2	107	2.0	1.3	1.3	14	68	2.0
Beam - 10 deg.	8	44	4.5	1.5	1.5	51	3.6	1.6	1.5	53.3	3.2	1.7	1.6	18	37	2.7

**Walls and Vertical Objects**

H	Height from ceiling to center of beam
D	Distance from fixture to wall
F.C.	Footcandles at center of beam
L	Length of effective lighted area
W	Width of effective lighted area
S	Spacing of multiple fixtures to effectively light wall

**Horizontal Surfaces**

Clg. Ht.	Height from floor to ceiling
F.C.	Footcandles 30" from floor (work plane)
Dia. & Spacing	Diameter of effective lighted area and spacing to effectively light the horizontal surface

CBCP - Center Beam Candlepower  
\*L is height of wall

## PAR38 and BR40 Lamp Application Data

Figure 1  
Single lampholder

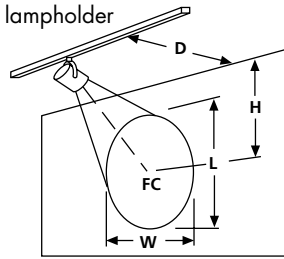
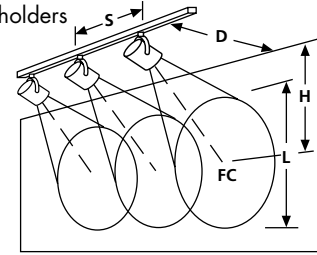

Figure 2  
Multiple lampholders



BR40  
Flood Lamps



BR40  
Spot Lamps



PAR38  
Flood Lamps



PAR38  
Spot Lamps



Walls and Vertical Objects														Horizontal Surfaces		
H	F.C.	L	W	S	F.C.	L	W	S	F.C.	L	W	S	Clg. Ht.	F.C.	Dia. & Spacing	
					D = 2 FT				D = 3 FT				D = 4 FT			
120BR40FL	2	88	6.9	3.3	2.4	64	5.9	4.2	3.1	45	6.3	5.2	3.8	8	33	5.5
CBCP - 1,000 Beam - 60 deg.	3	43	299	4.2	3.1	39	10.4	4.9	3.6	32	8.9	5.8	4.3	9	24	6.5
	4	22	*	5.2	3.8	24	23.5	5.8	4.3	22	13.9	6.5	4.8	10	18	7.5
300R40FL	3	124	*	12.5	6.7	114	*	14.7	7.8	93	*	17.3	9.2	8	96	9.5
CBCP - 2,900 Beam - 120 deg.	4	65	*	15.5	8.3	70	*	17.3	9.2	64	*	19.6	10.5	10	52	13.0
	5	37	*	18.7	9.9	44	*	20.2	10.8	44	*	22.2	11.8	12	32	16.5
					D = 3 FT				D = 4 FT				D = 5 FT			
120BR40SP	4	111	3.1	1.8	1.7	102	2.9	2.0	1.9	87	3.0	2.3	2.2	10	82	2.6
CBCP - 4,600 Beam - 20 deg.	6	46	6.0	2.4	2.3	49	4.9	2.5	2.4	54	4.1	2.6	2.5	12	51	3.3
	8	22	11.0	3.0	2.9	26	8.0	3.2	3.0	27	6.8	3.3	3.2	14	35	4.0
300R40SP	4	337	7.9	3.6	3.1	309	6.7	4.1	3.5	266	6.5	4.7	4.0	10	249	5.1
CBCP - 14,000 Beam - 40 deg.	6	140	23.1	4.9	4.2	149	13.5	5.2	4.5	165	9.8	5.5	4.7	12	155	6.5
	8	68	*	6.2	5.3	79	30.8	6.5	5.6	83	19.6	6.9	5.8	14	106	7.9
					D = 2 FT				D = 3 FT				D = 4 FT			
75PAR38FL	3	171	3.2	1.6	1.5	157	2.8	1.9	1.8	128	2.9	2.2	2.1	8	132	2.4
CBCP - 4,000 Beam - 25 deg.	4	90	5.5	2.0	1.9	96	4.0	2.2	2.1	88	3.7	2.5	2.3	9	95	2.8
	5	51	9.3	2.4	2.2	60	5.8	2.6	2.4	61	4.9	2.8	2.7	10	71	3.2
90PAR38FL	3	222	2.7	1.5	1.4	161	2.8	1.9	1.8	122	3.0	2.3	2.1	8	136	2.4
CBCP - 4,100 Beam - 25 deg.	4	92	5.5	2.0	1.9	78	4.9	2.4	2.2	76	4.3	2.7	2.5	9	97	2.8
	5	45	11.0	2.5	2.4	41	8.3	3.0	2.8	38	7.2	3.3	3.1	10	73	3.2
120PAR38FL	3	214	4.2	1.9	1.8	196	3.5	2.3	2.1	160	3.5	2.7	2.4	8	165	2.8
CBCP - 5,000 Beam - 30 deg.	4	112	7.5	2.4	2.2	120	5.1	2.7	2.4	110	4.6	3.0	2.8	9	118	3.4
	5	64	14.1	2.9	2.6	76	7.6	3.1	2.8	76	6.2	3.4	3.1	10	89	3.9
150PAR38FL	3	193	4.2	1.9	1.8	176	3.5	2.3	2.1	144	3.5	2.7	2.4	8	148.5	2.8
CBCP - 4,500 Beam - 30 deg.	4	101	7.5	2.4	2.2	108	5.1	2.7	2.4	99	4.6	3.0	2.8	9	106.2	3.4
	5	58	14.1	2.9	2.6	68	7.6	3.1	2.8	68	6.2	3.4	3.1	10	80.1	3.9
250PAR38FL	3	132	5.3	2.3	2.0	122	4.2	2.7	2.4	99	4.2	3.2	2.8	8	102	3.3
CBCP - 3,100 Beam - 35 deg.	4	70	10.4	2.8	2.5	75	6.4	3.2	2.8	69	5.6	3.6	3.1	9	73	3.9
	5	40	24.2	3.4	3.0	47	9.9	3.7	3.2	47	7.6	4.0	3.6	10	55	4.5
					D = 3 FT				D = 4 FT				D = 5 FT			
75PAR38SP	4	313	1.3	0.8	0.8	287	1.3	0.9	0.9	247	1.3	1.0	1.0	10	231	1.2
CBCP - 13,000 Beam - 9 deg.	6	130	2.4	1.1	1.0	139	2.1	1.1	1.1	154	1.8	1.6	1.2	12	144	1.5
	8	63	4.0	1.3	1.3	73	3.2	1.4	1.4	77	2.8	2.0	1.5	14	98	1.8
90PAR38SP	4	385	1.5	0.9	0.9	354	1.4	1.0	1.0	304	1.4	1.1	1.1	10	284	1.3
CBCP - 16,000 Beam - 10 deg.	6	160	2.7	1.2	1.2	171	2.3	1.3	1.2	189	2.0	1.3	1.3	12	121	2.0
	8	77	4.5	1.5	1.5	90	3.6	1.6	1.5	95	3.2	1.7	1.6	14	67	2.7
					D = 4 FT				D = 5 FT				D = 6 FT			
120PAR38SP	8	338	1.8	1.0	1.0	354	1.6	1.1	1.1	330	1.6	1.2	1.2	16	137	2.1
CBCP - 25,000 Beam - 9 deg.	10	140	3.2	1.4	1.4	171	2.6	1.4	1.4	205	2.1	1.4	1.4	18	104	2.4
	12	68	5.3	1.8	1.8	90	4.0	1.8	1.7	103	3.4	1.8	1.8	20	82	2.7
150PAR38SP	8	244	2.4	1.4	1.4	255	2.1	1.5	1.5	238	2.1	1.6	1.6	12	199	2.0
CBCP - 18,000 Beam - 12 deg.	10	101	4.4	1.9	1.8	123	3.5	1.9	1.9	148	2.9	1.9	1.9	14	136	2.4
	12	49	7.4	2.4	2.4	65	5.5	2.3	2.3	74	4.6	2.4	2.3	16	99	2.8

**Walls and Vertical Objects**

H	Height from ceiling to center of beam
D	Distance from fixture to wall
F.C.	Footcandles at center of beam
L	Length of effective lighted area
W	Width of effective lighted area
S	Spacing of multiple fixtures to effectively light wall

**Horizontal Surfaces**

Clg. Ht.	Height from floor to ceiling
F.C.	Footcandles 30" from floor (work plane)
Dia. & Spacing	Diameter of effective lighted area and spacing to effectively light the horizontal surface

CBCP - Center Beam Candlepower  
\*L is height of wall