

Type	-28	-31
P9200	<input type="checkbox"/>	<input type="checkbox"/>
P9201	<input type="checkbox"/>	<input type="checkbox"/>
P9202	<input type="checkbox"/>	<input type="checkbox"/>

Catalog No.	Finish		Lamping	Dimensions (Inches)	
	White	Black		A	B
P9200	-28	-31	75PAR16/50R/PAR20	3-1/2	7-5/8
P9201	-28	-31	75PAR30/65BR30	4-3/8	8-3/4
P9202	-28	-31	300BR40/250PAR38	5-5/8	10-7/8

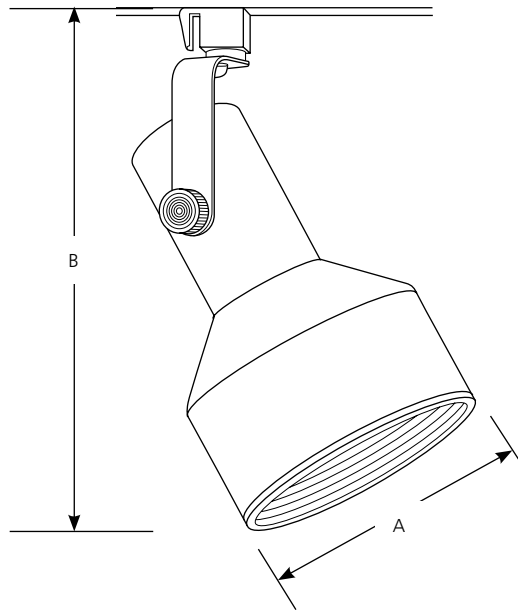

**Specifications:**

Track Lock Up

- For use with Alpha (P9100 Series) track
- Polarity oriented
- Quarter-turn locking action
- Tab lock to track to prevent accidental removal

Track Head Support

- Steel half yoke
- 358-degree horizontal rotation
- P9200 & P9201 have self-locking pivot for vertical head positioning
- P9202 has external lock nut for vertical head positioning

Track Head

- One piece steel construction
- Socket mount – two screws to prevent turning
- Porcelain socket with nickel-plated brass screw shell

Baffle

- Furnished with phenolic black baffle
- Spring clip retention

Labeling

- UL-CUL dry location listed

Photometrics

- Refer to Lamp Application Data for:
  - R20, PAR20 & PAR16
  - BR30 & PAR30
  - PAR38 & BR40

## R20, PAR16 and PAR20 Lamp Application Data

Figure 1  
Single lampholder

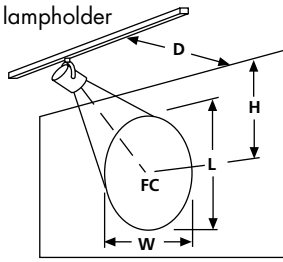
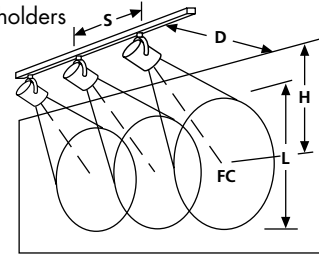

Figure 2  
Multiple lampholders



R20 Flood Lamps



	Walls and Vertical Objects												Horizontal Surfaces			
	H	F.C.	L	W	S	F.C.	L	W	S	F.C.	L	W	S	Clg. Ht.	F.C.	Dia. & Spacing
	D = 2 FT				D = 3 FT				D = 4 FT							
30R20FL	2	27	2.3	1.5	1.4	19	2.4	1.9	1.8	13	2.7	2.4	2.2	8	10	2.8
CBCP - 300 Beam - 30 deg.	3	13	4.2	1.9	1.8	12	3.5	2.3	2.1	10	3.5	2.7	2.4	9	7	3.4
	4	7	7.5	2.4	2.2	7	5.1	2.7	2.4	7	4.6	3.0	2.8	10	5	3.9
50R20FL	2	47	4.0	2.3	1.9	35	3.9	3.0	2.5	25	4.3	3.7	3.1	8	18	4.2
CBCP - 550 Beam - 45 deg.	3	23	8.8	3.0	2.5	22	6.0	3.5	2.9	18	5.7	4.1	3.4	9	13	5
	4	12	26.2	3.7	3.1	13	9.9	4.1	3.4	12	8.0	4.7	3.9	10	10	5.7
P75R20	2	57	4.0	2.3	1.9	42	3.9	3.0	2.5	29	4.3	3.7	3.1	8	21	4.2
CBCP - 650 Beam - 45 deg.	3	28	8.8	3.0	2.5	26	6.0	3.5	2.9	21	5.7	4.1	3.4	9	15	5.0
	4	15	26.2	3.7	3.1	16	9.9	4.1	3.4	14	8.0	4.7	3.9	10	12	5.7

PAR16 & PAR20 Flood Lamps



PAR16



PAR20

	Walls and Vertical Objects												Horizontal Surfaces			
	H	F.C.	L	W	S	F.C.	L	W	S	F.C.	L	W	S	Clg. Ht.	F.C.	Dia. & Spacing
	D = 2 FT				D = 3 FT				D = 4 FT							
45PAR16NFL	2	124	2.0	1.4	1.3	90	2.1	1.7	1.6	63	2.4	2.1	2.0	8	46	2.6
CBCP - 1,400 Beam - 27 deg.	3	60	3.6	1.7	1.6	55	3.1	2.0	1.9	45	3.1	2.4	2.2	9	33	3.0
	4	31	6.2	2.1	2.0	34	4.5	2.4	2.2	31	4.1	2.7	2.5	10	25	3.5
50PAR20NFL	3	60	4.2	1.9	1.8	55	3.5	2.3	2.1	45	3.5	2.7	2.4	8	46	2.8
CBCP - 1,400 Beam - 30 deg.	4	31	7.5	2.4	2.2	34	5.1	2.7	2.4	31	4.6	3.0	2.8	9	33	3.4
	5	18	14.1	2.9	2.6	21	7.6	3.1	2.8	21	6.2	3.4	3.1	10	25	3.9
60/75PAR16NFL	3	85	3.6	1.7	1.6	79	3.1	2.0	1.9	64	3.1	2.4	2.2	8	66	2.6
CBCP - 2,000 Beam - 27 deg.	4	45	6.2	2.1	2.0	48	4.5	2.4	2.2	44	4.1	2.7	2.7	9	48	3.0
	5	29	10.9	2.6	2.4	30	6.5	2.8	2.6	31	5.4	3.1	3.1	10	36	3.5

PAR16 & PAR20 Spot Lamps



PAR16



PAR20

	Walls and Vertical Objects												Horizontal Surfaces			
	H	F.C.	L	W	S	F.C.	L	W	S	F.C.	L	W	S	Clg. Ht.	F.C.	Dia. & Spacing
	D = 2 FT				D = 3 FT				D = 4 FT							
45PAR16NSP	4	112	1.8	0.8	0.8	120	1.5	0.9	0.9	110	1.4	1.0	1.0	8	89	1.3
CBCP - 5,000 Beam - 10 deg.	5	64	2.7	0.9	0.9	76	2.0	1.0	1.0	76	1.8	1.1	1.1	10	55	1.7
	6	39	3.8	1.1	1.1	50	2.7	1.2	1.2	53	2.3	1.3	1.2	12	38	2.0
50PAR20NSP	4	149	1.3	0.8	0.8	137	1.3	0.9	0.9	118	1.3	1.0	1.0	10	110	1.2
CBCP - 6,200 Beam - 9 deg.	6	62	2.4	1.1	1.0	66	2.1	1.1	1.1	73	1.8	1.2	1.2	12	69	1.5
	8	30	4.0	1.3	1.3	35	3.2	1.4	1.4	37	2.8	1.5	1.5	14	48	1.8
60/75PAR16NSP	4	180	1.5	0.9	0.9	166	1.4	1.0	1.0	143	1.4	1.1	1.1	10	133	1.3
CBCP - 7,500 Beam - 10 deg.	6	75	2.7	1.2	1.2	80	2.3	1.3	1.2	89	2.0	1.3	1.3	12	83	1.7
	8	36	4.5	1.5	1.5	42	3.6	1.6	1.5	45	3.2	1.7	1.6	14	57	2.0

Walls and Vertical Objects

H	Height from ceiling to center of beam
D	Distance from fixture to wall
F.C.	Footcandles at center of beam
L	Length of effective lighted area
W	Width of effective lighted area
S	Spacing of multiple fixtures to effectively light wall

Horizontal Surfaces

Clg. Ht.	Height from floor to ceiling
F.C.	Footcandles 30" from floor (work plane)
Dia. & Spacing	Diameter of effective lighted area and spacing to effectively light the horizontal surface
CBCP - Center Beam Candlepower	

## BR30 and PAR30 Lamp Application Data

Figure 1  
Single lampholder

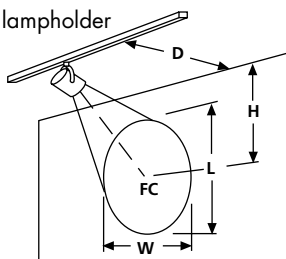
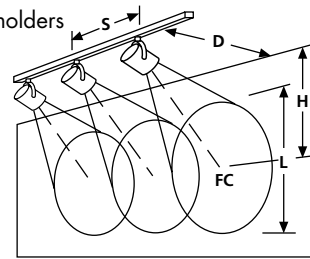

Figure 2  
Multiple lampholders



BR30 Flood Lamp



BR30 Spot Lamp



PAR30 Flood Lamps



PAR30 Spot Lamps



Walls and Vertical Objects														Horizontal Surfaces			
H	F.C.	L	W	S	F.C.	L	W	S	F.C.	L	W	S	Clg. Ht.	F.C.	Dia. & Spacing		
D = 2 FT				D = 3 FT				D = 4 FT									
65BR30FL	2	46	5.7	2.9	2.3	34	5.1	3.8	2.9	23	5.6	4.7	3.6	8	17	5.1	
	CBCP - 525	3	22	17.3	3.8	2.9	21	8.6	4.4	3.4	17	12.0	5.2	4.0	9	12	6
	Beam - 55 deg.	4	12	*	4.7	3.6	13	16.7	5.2	4.0	11	11.4	5.9	4.5	10	9	6.9
Walls and Vertical Objects														Horizontal Surfaces			
H	F.C.	L	W	S	F.C.	L	W	S	F.C.	L	W	S	Clg. Ht.	F.C.	Dia. & Spacing		
D = 2 FT				D = 3 FT				D = 4 FT									
65BR30SP	3	69	2.5	1.3	1.2	64	2.2	1.5	1.4	52	2.2	1.8	1.7	8	54	1.9	
	CBCP - 1625	4	36	4.0	1.6	1.5	39	3.1	1.8	1.7	36	2.9	2.0	1.9	9	38	2.3
	Beam - 20 deg.	5	21	6.3	1.9	1.8	25	4.4	2.1	2.0	25	3.8	2.3	2.2	10	29	2.6
Walls and Vertical Objects														Horizontal Surfaces			
H	F.C.	L	W	S	F.C.	L	W	S	F.C.	L	W	S	Clg. Ht.	F.C.	Dia. & Spacing		
D = 2 FT				D = 3 FT				D = 4 FT									
50PAR30/HIR/FL	3	64	5.3	2.3	2.0	59	4.2	2.7	2.4	48	4.2	3.2	2.8	8	50	3.3	
	CBCP - 1500	4	34	10.4	2.8	2.5	36	6.4	3.2	2.8	33	5.6	3.6	3.1	9	36	3.9
	Beam - 35 deg.	5	19	24.2	3.4	3.0	23	9.9	3.7	3.2	23	7.6	4.0	3.6	10	27	4.5
50PAR30FL	3	60	5.3	2.3	2.0	55	4.2	2.7	2.4	45	4.2	3.2	2.8	8	46	3.3	
	CBCP - 1400	4	31	10.4	2.8	2.5	34	6.4	3.2	2.8	31	5.6	3.6	3.1	9	33	3.9
	Beam - 35 deg.	5	18	24.2	3.4	3.0	21	9.9	3.7	3.2	21	7.6	4.0	3.6	10	25	4.5
75PAR30FL	3	85	5.8	2.4	2.1	79	4.5	2.8	2.5	64	4.5	3.3	2.9	8	66	3.5	
	CBCP - 2000	4	45	12.1	3.0	2.6	48	6.9	3.3	2.9	44	6.0	3.8	3.3	9	47	4.1
	Beam - 35 deg.	5	26	32.3	3.6	3.1	30	11.0	3.9	3.4	31	8.3	4.3	3.7	10	36	4.8
75PAR30FL-L	3	133	3.2	1.6	1.5	122	2.8	1.9	1.8	90	2.9	2.2	2.1	8	102	2.4	
	CBCP - 3100	4	70	5.5	2.0	1.9	74	4.0	2.2	2.1	68	3.7	2.5	2.3	9	74	2.8
	Beam - 25 deg.	5	40	9.3	2.4	2.2	47	5.8	2.6	2.4	40	4.9	2.8	2.7	10	55	3.2
Walls and Vertical Objects														Horizontal Surfaces			
H	F.C.	L	W	S	F.C.	L	W	S	F.C.	L	W	S	Clg. Ht.	F.C.	Dia. & Spacing		
D = 3 FT				D = 4 FT				D = 5 FT									
50PAR30/HIR/NSP	4	313	1.3	0.8	0.8	287	1.3	0.9	0.9	247	1.3	1.0	1.0	12	144	1.5	
	CBCP - 13,000	6	130	2.4	1.1	1.0	139	2.1	1.1	1.1	154	1.8	1.2	1.2	16	71	2.1
	Beam - 9 deg.	8	63	4.0	1.3	1.3	73	3.2	1.4	1.4	77	2.8	1.5	1.5	20	42	2.7
50PAR20NSP	4	166	1.5	0.9	0.9	152	1.4	1.0	1.0	131	1.4	1.1	1.1	10	123	1.3	
	CBCP - 6,900	6	69	2.7	1.2	1.2	74	2.3	1.3	1.2	81	2.0	1.3	1.3	12	76	1.7
	Beam - 10 deg.	8	33	4.5	1.5	1.5	39	3.6	1.6	1.5	41	3.2	1.7	1.6	14	52	2.0
75PAR30NSP	4	313	1.5	0.9	0.9	287	1.4	1.0	1.0	247	1.4	1.1	1.1	10	231	1.3	
	CBCP - 13,000	6	130	2.7	1.2	1.2	139	2.3	1.3	1.2	154	2.0	1.3	1.3	14	98	2.0
	Beam - 10 deg.	8	63	4.5	1.5	1.5	73	3.6	1.6	1.5	77	3.2	1.7	1.6	18	54	2.7
75PAR30NSP-L	4	217	1.5	0.9	0.9	199	1.4	1.0	1.0	171	1.4	1.1	1.1	10	160	1.3	
	CBCP - 9,000	6	90	2.7	1.2	1.2	96	2.3	1.3	1.2	107	2.0	1.3	1.3	14	68	2.0
	Beam - 10 deg.	8	44	4.5	1.5	1.5	51	3.6	1.6	1.5	53.3	3.2	1.7	1.6	18	37	2.7

Walls and Vertical Objects

H	Height from ceiling to center of beam
D	Distance from fixture to wall
F.C.	Footcandles at center of beam
L	Length of effective lighted area
W	Width of effective lighted area
S	Spacing of multiple fixtures to effectively light wall

Horizontal Surfaces

Clg. Ht.	Height from floor to ceiling
F.C.	Footcandles 30" from floor (work plane)
Dia. & Spacing	Diameter of effective lighted area and spacing to effectively light the horizontal surface
CBCP - Center Beam Candlepower	
*L is height of wall	

**PAR38 and BR40 Lamp Application Data**

Figure 1  
Single lampholder

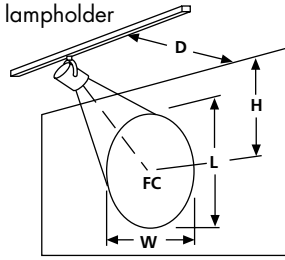
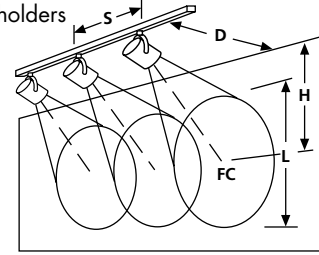

Figure 2  
Multiple lampholders



BR40  
Flood Lamps



BR40  
Spot Lamps



PAR38  
Flood Lamps



PAR38  
Spot Lamps



Walls and Vertical Objects													Horizontal Surfaces		
H	F.C.	L	W	S	F.C.	L	W	S	F.C.	L	W	S	Clg. Ht.	F.C.	Dia. & Spacing

Walls and Vertical Objects													Horizontal Surfaces			
H	F.C.	L	W	S	F.C.	L	W	S	F.C.	L	W	S	Clg. Ht.	F.C.	Dia. & Spacing	
													D = 2 FT			
120BR40FL	2	88	6.9	3.3	2.4	64	5.9	4.2	3.1	45	6.3	5.2	3.8	8	33	5.5
CBCP - 1,000 Beam - 60 deg.	3	43	299	4.2	3.1	39	10.4	4.9	3.6	32	8.9	5.8	4.3	9	24	6.5
	4	22	*	5.2	3.8	24	23.5	5.8	4.3	22	13.9	6.5	4.8	10	18	7.5
300R40FL	3	124	*	12.5	6.7	114	*	14.7	7.8	93	*	17.3	9.2	8	96	9.5
CBCP - 2,900 Beam - 120 deg.	4	65	*	15.5	8.3	70	*	17.3	9.2	64	*	19.6	10.5	10	52	13.0
	5	37	*	18.7	9.9	44	*	20.2	10.8	44	*	22.2	11.8	12	32	16.5
													D = 3 FT			
120BR40SP	4	111	3.1	1.8	1.7	102	2.9	2.0	1.9	87	3.0	2.3	2.2	10	82	2.6
CBCP - 4,600 Beam - 20 deg.	6	46	6.0	2.4	2.3	49	4.9	2.5	2.4	54	4.1	2.6	2.5	12	51	3.3
	8	22	11.0	3.0	2.9	26	8.0	3.2	3.0	27	6.8	3.3	3.2	14	35	4.0
300R40SP	4	337	7.9	3.6	3.1	309	6.7	4.1	3.5	266	6.5	4.7	4.0	10	249	5.1
CBCP - 14,000 Beam - 40 deg.	6	140	23.1	4.9	4.2	149	13.5	5.2	4.5	165	9.8	5.5	4.7	12	155	6.5
	8	68	*	6.2	5.3	79	30.8	6.5	5.6	83	19.6	6.9	5.8	14	106	7.9
													D = 4 FT			
75PAR38FL	3	171	3.2	1.6	1.5	157	2.8	1.9	1.8	128	2.9	2.2	2.1	8	132	2.4
CBCP - 4,000 Beam - 25 deg.	4	90	5.5	2.0	1.9	96	4.0	2.2	2.1	88	3.7	2.5	2.3	9	95	2.8
	5	51	9.3	2.4	2.2	60	5.8	2.6	2.4	61	4.9	2.8	2.7	10	71	3.2
90PAR38FL	3	222	2.7	1.5	1.4	161	2.8	1.9	1.8	122	3.0	2.3	2.1	8	136	2.4
CBCP - 4,100 Beam - 25 deg.	4	92	5.5	2.0	1.9	78	4.9	2.4	2.2	76	4.3	2.7	2.5	9	97	2.8
	5	45	11.0	2.5	2.4	41	8.3	3.0	2.8	38	7.2	3.3	3.1	10	73	3.2
120PAR38FL	3	214	4.2	1.9	1.8	196	3.5	2.3	2.1	160	3.5	2.7	2.4	8	165	2.8
CBCP - 5,000 Beam - 30 deg.	4	112	7.5	2.4	2.2	120	5.1	2.7	2.4	110	4.6	3.0	2.8	9	118	3.4
	5	64	14.1	2.9	2.6	76	7.6	3.1	2.8	76	6.2	3.4	3.1	10	89	3.9
150PAR38FL	3	193	4.2	1.9	1.8	176	3.5	2.3	2.1	144	3.5	2.7	2.4	8	148.5	2.8
CBCP - 4,500 Beam - 30 deg.	4	101	7.5	2.4	2.2	108	5.1	2.7	2.4	99	4.6	3.0	2.8	9	106.2	3.4
	5	58	14.1	2.9	2.6	68	7.6	3.1	2.8	68	6.2	3.4	3.1	10	80.1	3.9
250PAR38FL	3	132	5.3	2.3	2.0	122	4.2	2.7	2.4	99	4.2	3.2	2.8	8	102	3.3
CBCP - 3,100 Beam - 35 deg.	4	70	10.4	2.8	2.5	75	6.4	3.2	2.8	69	5.6	3.6	3.1	9	73	3.9
	5	40	24.2	3.4	3.0	47	9.9	3.7	3.2	47	7.6	4.0	3.6	10	55	4.5
													D = 3 FT			
75PAR38SP	4	313	1.3	0.8	0.8	287	1.3	0.9	0.9	247	1.3	1.0	1.0	10	231	1.2
CBCP - 13,000 Beam - 9 deg.	6	130	2.4	1.1	1.0	139	2.1	1.1	1.1	154	1.8	1.6	1.2	12	144	1.5
	8	63	4.0	1.3	1.3	73	3.2	1.4	1.4	77	2.8	2.0	1.5	14	98	1.8
90PAR38SP	4	385	1.5	0.9	0.9	354	1.4	1.0	1.0	304	1.4	1.1	1.1	10	284	1.3
CBCP - 16,000 Beam - 10 deg.	6	160	2.7	1.2	1.2	171	2.3	1.3	1.2	189	2.0	1.3	1.3	12	121	2.0
	8	77	4.5	1.5	1.5	90	3.6	1.6	1.5	95	3.2	1.7	1.6	14	67	2.7
													D = 4 FT			
120PAR38SP	8	338	1.8	1.0	1.0	354	1.6	1.1	1.1	330	1.6	1.2	1.2	16	137	2.1
CBCP - 25,000 Beam - 9 deg.	10	140	3.2	1.4	1.4	171	2.6	1.4	1.4	205	2.1	1.4	1.4	18	104	2.4
	12	68	5.3	1.8	1.8	90	4.0	1.8	1.7	103	3.4	1.8	1.8	20	82	2.7
150PAR38SP	8	244	2.4	1.4	1.4	255	2.1	1.5	1.5	238	2.1	1.6	1.6	12	199	2.0
CBCP - 18,000 Beam - 12 deg.	10	101	4.4	1.9	1.8	123	3.5	1.9	1.9	148	2.9	1.9	1.9	14	136	2.4
	12	49	7.4	2.4	2.4	65	5.5	2.3	2.3	74	4.6	2.4	2.3	16	99	2.8

Walls and Vertical Objects  
H Height from ceiling to center of beam  
D Distance from fixture to wall  
F.C. Footcandles at center of beam  
L Length of effective lighted area  
W Width of effective lighted area  
S Spacing of multiple fixtures to effectively light wall

Horizontal Surfaces  
Clg. Ht. Height from floor to ceiling  
F.C. Footcandles 30" from floor (work plane)  
Dia. & Spacing Diameter of effective lighted area and spacing to effectively light the horizontal surface  
CBCP - Center Beam Candlepower  
\*L is height of wall