

Type	-28	-31
P9200	<input type="checkbox"/>	<input type="checkbox"/>
P9201	<input type="checkbox"/>	<input type="checkbox"/>
P9202	<input type="checkbox"/>	<input type="checkbox"/>

Catalog No.	Finish		Lamping	Dimensions (Inches)	
	White	Black		A	B
P9205	-28	-31	75PAR16/50R/PAR20	3-1/2	7-1/4
P9206	-28	-31	75PAR30/65BR30	4-3/8	9
P9207	-28	-31	300BR40/250PAR38	5-3/4	10-5/8

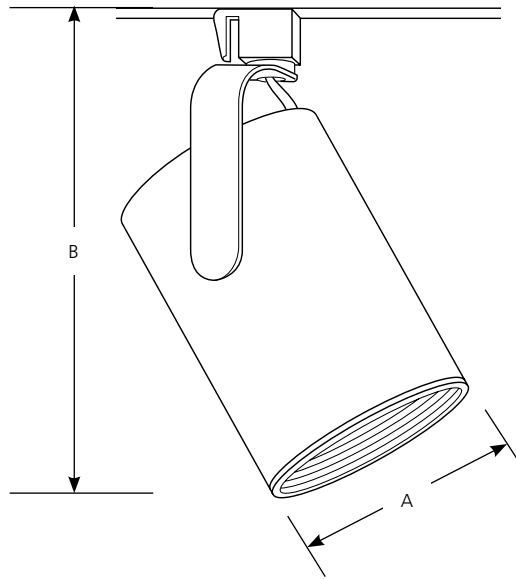

Specifications:

Track Lock Up

- For use with Alpha (P9100 Series) track
- Polarity oriented
- Quarter-turn locking action
- Tab lock to track to prevent accidental removal

Track Head Support

- Steel half yoke
- 358-degree horizontal rotation
- P9205 & P9206 have self-locking pivot for vertical head positioning
- P9207 has external lock knob for vertical head positioning

Track Head

- One piece steel construction
- Socket mount – two screws to prevent turning
- Porcelain socket with nickel-plated brass screw shell

Baffle

- Furnished with phenolic black baffle
- Spring clip retention

Labeling

- UL-CUL dry location listed

Photometrics

- Refer to Lamp Application Data for:
 - R20, PAR20 & PAR16
 - BR30 & PAR30
 - PAR38 & BR40

R20, PAR16 and PAR20 Lamp Application Data

Figure 1
Single lampholder

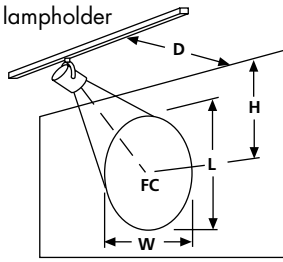
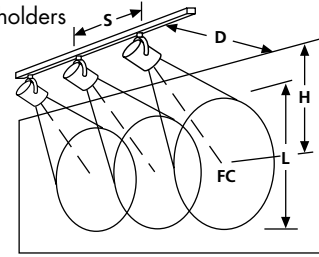

Figure 2
Multiple lampholders



R20 Flood Lamps



	Walls and Vertical Objects												Horizontal Surfaces			
	H	F.C.	L	W	S	F.C.	L	W	S	F.C.	L	W	S	Clg. Ht.	F.C.	Dia. & Spacing
	D = 2 FT				D = 3 FT				D = 4 FT							
30R20FL	2	27	2.3	1.5	1.4	19	2.4	1.9	1.8	13	2.7	2.4	2.2	8	10	2.8
CBCP - 300	3	13	4.2	1.9	1.8	12	3.5	2.3	2.1	10	3.5	2.7	2.4	9	7	3.4
Beam - 30 deg.	4	7	7.5	2.4	2.2	7	5.1	2.7	2.4	7	4.6	3.0	2.8	10	5	3.9
50R20FL	2	47	4.0	2.3	1.9	35	3.9	3.0	2.5	25	4.3	3.7	3.1	8	18	4.2
CBCP - 550	3	23	8.8	3.0	2.5	22	6.0	3.5	2.9	18	5.7	4.1	3.4	9	13	5
Beam - 45 deg.	4	12	26.2	3.7	3.1	13	9.9	4.1	3.4	12	8.0	4.7	3.9	10	10	5.7
P75R20	2	57	4.0	2.3	1.9	42	3.9	3.0	2.5	29	4.3	3.7	3.1	8	21	4.2
CBCP - 650	3	28	8.8	3.0	2.5	26	6.0	3.5	2.9	21	5.7	4.1	3.4	9	15	5.0
Beam - 45 deg.	4	15	26.2	3.7	3.1	16	9.9	4.1	3.4	14	8.0	4.7	3.9	10	12	5.7

PAR16 & PAR20 Flood Lamps



	Walls and Vertical Objects												Horizontal Surfaces			
	H	F.C.	L	W	S	F.C.	L	W	S	F.C.	L	W	S	Clg. Ht.	F.C.	Dia. & Spacing
	D = 2 FT				D = 3 FT				D = 4 FT							
45PAR16NFL	2	124	2.0	1.4	1.3	90	2.1	1.7	1.6	63	2.4	2.1	2.0	8	46	2.6
CBCP - 1,400	3	60	3.6	1.7	1.6	55	3.1	2.0	1.9	45	3.1	2.4	2.2	9	33	3.0
Beam - 27 deg.	4	31	6.2	2.1	2.0	34	4.5	2.4	2.2	31	4.1	2.7	2.5	10	25	3.5
50PAR20NFL	3	60	4.2	1.9	1.8	55	3.5	2.3	2.1	45	3.5	2.7	2.4	8	46	2.8
CBCP - 1,400	4	31	7.5	2.4	2.2	34	5.1	2.7	2.4	31	4.6	3.0	2.8	9	33	3.4
Beam - 30 deg.	5	18	14.1	2.9	2.6	21	7.6	3.1	2.8	21	6.2	3.4	3.1	10	25	3.9
60/75PAR16NFL	3	85	3.6	1.7	1.6	79	3.1	2.0	1.9	64	3.1	2.4	2.2	8	66	2.6
CBCP - 2,000	4	45	6.2	2.1	2.0	48	4.5	2.4	2.2	44	4.1	2.7	2.7	9	48	3.0
Beam - 27 deg.	5	29	10.9	2.6	2.4	30	6.5	2.8	2.6	31	5.4	3.1	3.1	10	36	3.5

PAR20



	Walls and Vertical Objects												Horizontal Surfaces			
	H	F.C.	L	W	S	F.C.	L	W	S	F.C.	L	W	S	Clg. Ht.	F.C.	Dia. & Spacing
	D = 2 FT				D = 3 FT				D = 4 FT							
45PAR16NSP	4	112	1.8	0.8	0.8	120	1.5	0.9	0.9	110	1.4	1.0	1.0	8	89	1.3
CBCP - 5,000	5	64	2.7	0.9	0.9	76	2.0	1.0	1.0	76	1.8	1.1	1.1	10	55	1.7
Beam - 10 deg.	6	39	3.8	1.1	1.1	50	2.7	1.2	1.2	53	2.3	1.3	1.2	12	38	2.0

PAR16 & PAR20 Spot Lamps



	Walls and Vertical Objects												Horizontal Surfaces			
	H	F.C.	L	W	S	F.C.	L	W	S	F.C.	L	W	S	Clg. Ht.	F.C.	Dia. & Spacing
	D = 3 FT				D = 4 FT				D = 5 FT							
50PAR20NSP	4	149	1.3	0.8	0.8	137	1.3	0.9	0.9	118	1.3	1.0	1.0	10	110	1.2
CBCP - 6,200	6	62	2.4	1.1	1.0	66	2.1	1.1	1.1	73	1.8	1.2	1.2	12	69	1.5
Beam - 9 deg.	8	30	4.0	1.3	1.3	35	3.2	1.4	1.4	37	2.8	1.5	1.5	14	48	1.8
60/75PAR16NSP	4	180	1.5	0.9	0.9	166	1.4	1.0	1.0	143	1.4	1.1	1.1	10	133	1.3
CBCP - 7,500	6	75	2.7	1.2	1.2	80	2.3	1.3	1.2	89	2.0	1.3	1.3	12	83	1.7
Beam - 10 deg.	8	36	4.5	1.5	1.5	42	3.6	1.6	1.5	45	3.2	1.7	1.6	14	57	2.0

PAR16



PAR20

Walls and Vertical Objects

H	Height from ceiling to center of beam
D	Distance from fixture to wall
F.C.	Footcandles at center of beam
L	Length of effective lighted area
W	Width of effective lighted area
S	Spacing of multiple fixtures to effectively light wall

Horizontal Surfaces

Clg. Ht.	Height from floor to ceiling
F.C.	Footcandles 30" from floor (work plane)
Dia. & Spacing	Diameter of effective lighted area and spacing to effectively light the horizontal surface
CBCP - Center Beam Candlepower	

BR30 and PAR30 Lamp Application Data

Figure 1
Single lampholder

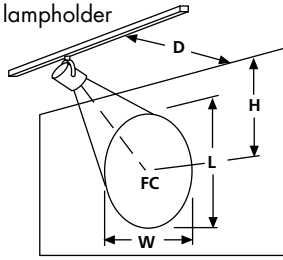
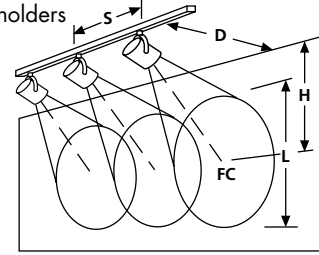

Figure 2
Multiple lampholders



BR30 Flood Lamp



BR30 Spot Lamp



PAR30 Flood Lamps



PAR30 Spot Lamps



Walls and Vertical Objects														Horizontal Surfaces			
H	F.C.	L	W	S	F.C.	L	W	S	F.C.	L	W	S	Clg. Ht.	F.C.	Dia. & Spacing		
D = 2 FT				D = 3 FT				D = 4 FT									
65BR30FL	2	46	5.7	2.9	2.3	34	5.1	3.8	2.9	23	5.6	4.7	3.6	8	17	5.1	
	CBCP - 525	3	22	17.3	3.8	2.9	21	8.6	4.4	3.4	17	12.0	5.2	4.0	9	12	6
	Beam - 55 deg.	4	12	*	4.7	3.6	13	16.7	5.2	4.0	11	11.4	5.9	4.5	10	9	6.9
Walls and Vertical Objects														Horizontal Surfaces			
H	F.C.	L	W	S	F.C.	L	W	S	F.C.	L	W	S	Clg. Ht.	F.C.	Dia. & Spacing		
D = 2 FT				D = 3 FT				D = 4 FT									
65BR30SP	3	69	2.5	1.3	1.2	64	2.2	1.5	1.4	52	2.2	1.8	1.7	8	54	1.9	
	CBCP - 1625	4	36	4.0	1.6	1.5	39	3.1	1.8	1.7	36	2.9	2.0	1.9	9	38	2.3
	Beam - 20 deg.	5	21	6.3	1.9	1.8	25	4.4	2.1	2.0	25	3.8	2.3	2.2	10	29	2.6
Walls and Vertical Objects														Horizontal Surfaces			
H	F.C.	L	W	S	F.C.	L	W	S	F.C.	L	W	S	Clg. Ht.	F.C.	Dia. & Spacing		
D = 2 FT				D = 3 FT				D = 4 FT									
50PAR30/HIR/FL	3	64	5.3	2.3	2.0	59	4.2	2.7	2.4	48	4.2	3.2	2.8	8	50	3.3	
	CBCP - 1500	4	34	10.4	2.8	2.5	36	6.4	3.2	2.8	33	5.6	3.6	3.1	9	36	3.9
	Beam - 35 deg.	5	19	24.2	3.4	3.0	23	9.9	3.7	3.2	23	7.6	4.0	3.6	10	27	4.5
50PAR30FL	3	60	5.3	2.3	2.0	55	4.2	2.7	2.4	45	4.2	3.2	2.8	8	46	3.3	
	CBCP - 1400	4	31	10.4	2.8	2.5	34	6.4	3.2	2.8	31	5.6	3.6	3.1	9	33	3.9
	Beam - 35 deg.	5	18	24.2	3.4	3.0	21	9.9	3.7	3.2	21	7.6	4.0	3.6	10	25	4.5
75PAR30FL	3	85	5.8	2.4	2.1	79	4.5	2.8	2.5	64	4.5	3.3	2.9	8	66	3.5	
	CBCP - 2000	4	45	12.1	3.0	2.6	48	6.9	3.3	2.9	44	6.0	3.8	3.3	9	47	4.1
	Beam - 35 deg.	5	26	32.3	3.6	3.1	30	11.0	3.9	3.4	31	8.3	4.3	3.7	10	36	4.8
75PAR30FL-L	3	133	3.2	1.6	1.5	122	2.8	1.9	1.8	90	2.9	2.2	2.1	8	102	2.4	
	CBCP - 3100	4	70	5.5	2.0	1.9	74	4.0	2.2	2.1	68	3.7	2.5	2.3	9	74	2.8
	Beam - 25 deg.	5	40	9.3	2.4	2.2	47	5.8	2.6	2.4	40	4.9	2.8	2.7	10	55	3.2
Walls and Vertical Objects														Horizontal Surfaces			
H	F.C.	L	W	S	F.C.	L	W	S	F.C.	L	W	S	Clg. Ht.	F.C.	Dia. & Spacing		
D = 3 FT				D = 4 FT				D = 5 FT									
50PAR30/HIR/NSP	4	313	1.3	0.8	0.8	287	1.3	0.9	0.9	247	1.3	1.0	1.0	12	144	1.5	
	CBCP - 13,000	6	130	2.4	1.1	1.0	139	2.1	1.1	1.1	154	1.8	1.2	1.2	16	71	2.1
	Beam - 9 deg.	8	63	4.0	1.3	1.3	73	3.2	1.4	1.4	77	2.8	1.5	1.5	20	42	2.7
50PAR20NSP	4	166	1.5	0.9	0.9	152	1.4	1.0	1.0	131	1.4	1.1	1.1	10	123	1.3	
	CBCP - 6,900	6	69	2.7	1.2	1.2	74	2.3	1.3	1.2	81	2.0	1.3	1.3	12	76	1.7
	Beam - 10 deg.	8	33	4.5	1.5	1.5	39	3.6	1.6	1.5	41	3.2	1.7	1.6	14	52	2.0
75PAR30NSP	4	313	1.5	0.9	0.9	287	1.4	1.0	1.0	247	1.4	1.1	1.1	10	231	1.3	
	CBCP - 13,000	6	130	2.7	1.2	1.2	139	2.3	1.3	1.2	154	2.0	1.3	1.3	14	98	2.0
	Beam - 10 deg.	8	63	4.5	1.5	1.5	73	3.6	1.6	1.5	77	3.2	1.7	1.6	18	54	2.7
75PAR30NSP-L	4	217	1.5	0.9	0.9	199	1.4	1.0	1.0	171	1.4	1.1	1.1	10	160	1.3	
	CBCP - 9,000	6	90	2.7	1.2	1.2	96	2.3	1.3	1.2	107	2.0	1.3	1.3	14	68	2.0
	Beam - 10 deg.	8	44	4.5	1.5	1.5	51	3.6	1.6	1.5	53.3	3.2	1.7	1.6	18	37	2.7

Walls and Vertical Objects	
H	Height from ceiling to center of beam
D	Distance from fixture to wall
F.C.	Footcandles at center of beam
L	Length of effective lighted area
W	Width of effective lighted area
S	Spacing of multiple fixtures to effectively light wall

Horizontal Surfaces	
Clg. Ht.	Height from floor to ceiling
F.C.	Footcandles 30" from floor (work plane)
Dia. & Spacing	Diameter of effective lighted area and spacing to effectively light the horizontal surface
CBCP - Center Beam Candlepower	
*L is height of wall	

PAR38 and BR40 Lamp Application Data

Figure 1
Single lampholder

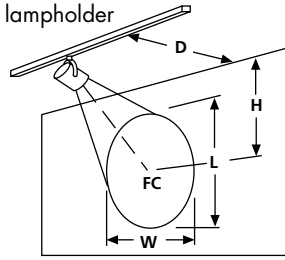
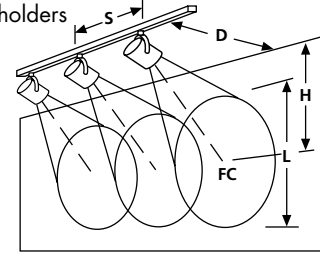

Figure 2
Multiple lampholders



BR40
Flood Lamps



BR40
Spot Lamps



PAR38
Flood Lamps



PAR38
Spot Lamps



Walls and Vertical Objects													Horizontal Surfaces		
H	F.C.	L	W	S	F.C.	L	W	S	F.C.	L	W	S	Clg. Ht.	F.C.	Dia. & Spacing

D = 2 FT																D = 3 FT				D = 4 FT			
120BR40FL	2	88	6.9	3.3	2.4	64	5.9	4.2	3.1	45	6.3	5.2	3.8	8	33	5.5							
CBCP - 1,000 Beam - 60 deg.	3	43	299	4.2	3.1	39	10.4	4.9	3.6	32	8.9	5.8	4.3	9	24	6.5							
	4	22	*	5.2	3.8	24	23.5	5.8	4.3	22	13.9	6.5	4.8	10	18	7.5							
300R40FL	3	124	*	12.5	6.7	114	*	14.7	7.8	93	*	17.3	9.2	8	96	9.5							
CBCP - 2,900 Beam - 120 deg.	4	65	*	15.5	8.3	70	*	17.3	9.2	64	*	19.6	10.5	10	52	13.0							
	5	37	*	18.7	9.9	44	*	20.2	10.8	44	*	22.2	11.8	12	32	16.5							
D = 3 FT																D = 4 FT				D = 5 FT			
120BR40SP	4	111	3.1	1.8	1.7	102	2.9	2.0	1.9	87	3.0	2.3	2.2	10	82	2.6							
CBCP - 4,600 Beam - 20 deg.	6	46	6.0	2.4	2.3	49	4.9	2.5	2.4	54	4.1	2.6	2.5	12	51	3.3							
	8	22	11.0	3.0	2.9	26	8.0	3.2	3.0	27	6.8	3.3	3.2	14	35	4.0							
300R40SP	4	337	7.9	3.6	3.1	309	6.7	4.1	3.5	266	6.5	4.7	4.0	10	249	5.1							
CBCP - 14,000 Beam - 40 deg.	6	140	23.1	4.9	4.2	149	13.5	5.2	4.5	165	9.8	5.5	4.7	12	155	6.5							
	8	68	*	6.2	5.3	79	30.8	6.5	5.6	83	19.6	6.9	5.8	14	106	7.9							
D = 2 FT																D = 3 FT				D = 4 FT			
75PAR38FL	3	171	3.2	1.6	1.5	157	2.8	1.9	1.8	128	2.9	2.2	2.1	8	132	2.4							
CBCP - 4,000 Beam - 25 deg.	4	90	5.5	2.0	1.9	96	4.0	2.2	2.1	88	3.7	2.5	2.3	9	95	2.8							
	5	51	9.3	2.4	2.2	60	5.8	2.6	2.4	61	4.9	2.8	2.7	10	71	3.2							
90PAR38FL	3	222	2.7	1.5	1.4	161	2.8	1.9	1.8	122	3.0	2.3	2.1	8	136	2.4							
CBCP - 4,100 Beam - 25 deg.	4	92	5.5	2.0	1.9	78	4.9	2.4	2.2	76	4.3	2.7	2.5	9	97	2.8							
	5	45	11.0	2.5	2.4	41	8.3	3.0	2.8	38	7.2	3.3	3.1	10	73	3.2							
120PAR38FL	3	214	4.2	1.9	1.8	196	3.5	2.3	2.1	160	3.5	2.7	2.4	8	165	2.8							
CBCP - 5,000 Beam - 30 deg.	4	112	7.5	2.4	2.2	120	5.1	2.7	2.4	110	4.6	3.0	2.8	9	118	3.4							
	5	64	14.1	2.9	2.6	76	7.6	3.1	2.8	76	6.2	3.4	3.1	10	89	3.9							
150PAR38FL	3	193	4.2	1.9	1.8	176	3.5	2.3	2.1	144	3.5	2.7	2.4	8	148.5	2.8							
CBCP - 4,500 Beam - 30 deg.	4	101	7.5	2.4	2.2	108	5.1	2.7	2.4	99	4.6	3.0	2.8	9	106.2	3.4							
	5	58	14.1	2.9	2.6	68	7.6	3.1	2.8	68	6.2	3.4	3.1	10	80.1	3.9							
250PAR38FL	3	132	5.3	2.3	2.0	122	4.2	2.7	2.4	99	4.2	3.2	2.8	8	102	3.3							
CBCP - 3,100 Beam - 35 deg.	4	70	10.4	2.8	2.5	75	6.4	3.2	2.8	69	5.6	3.6	3.1	9	73	3.9							
	5	40	24.2	3.4	3.0	47	9.9	3.7	3.2	47	7.6	4.0	3.6	10	55	4.5							
D = 3 FT																D = 4 FT				D = 5 FT			
75PAR38SP	4	313	1.3	0.8	0.8	287	1.3	0.9	0.9	247	1.3	1.0	1.0	10	231	1.2							
CBCP - 13,000 Beam - 9 deg.	6	130	2.4	1.1	1.0	139	2.1	1.1	1.1	154	1.8	1.6	1.2	12	144	1.5							
	8	63	4.0	1.3	1.3	73	3.2	1.4	1.4	77	2.8	2.0	1.5	14	98	1.8							
90PAR38SP	4	385	1.5	0.9	0.9	354	1.4	1.0	1.0	304	1.4	1.1	1.1	10	284	1.3							
CBCP - 16,000 Beam - 10 deg.	6	160	2.7	1.2	1.2	171	2.3	1.3	1.2	189	2.0	1.3	1.3	12	121	2.0							
	8	77	4.5	1.5	1.5	90	3.6	1.6	1.5	95	3.2	1.7	1.6	14	67	2.7							
D = 4 FT																D = 5 FT				D = 6 FT			
120PAR38SP	8	338	1.8	1.0	1.0	354	1.6	1.1	1.1	330	1.6	1.2	1.2	16	137	2.1							
CBCP - 25,000 Beam - 9 deg.	10	140	3.2	1.4	1.4	171	2.6	1.4	1.4	205	2.1	1.4	1.4	18	104	2.4							
	12	68	5.3	1.8	1.8	90	4.0	1.8	1.7	103	3.4	1.8	1.8	20	82	2.7							
150PAR38SP	8	244	2.4	1.4	1.4	255	2.1	1.5	1.5	238	2.1	1.6	1.6	12	199	2.0							
CBCP - 18,000 Beam - 12 deg.	10	101	4.4	1.9	1.8	123	3.5	1.9	1.9	148	2.9	1.9	1.9	14	136	2.4							
	12	49	7.4	2.4	2.4	65	5.5	2.3	2.3	74	4.6	2.4	2.3	16	99	2.8							

Walls and Vertical Objects
H Height from ceiling to center of beam
D Distance from fixture to wall
F.C. Footcandles at center of beam
L Length of effective lighted area
W Width of effective lighted area
S Spacing of multiple fixtures to effectively light wall

Horizontal Surfaces
Clg. Ht. Height from floor to ceiling
F.C. Footcandles 30" from floor (work plane)
Dia. & Spacing Diameter of effective lighted area and spacing to effectively light the horizontal surface
CBCP - Center Beam Candlepower
*L is height of wall