

Spot

This durable, fully sealed 12V LED landscape spot is constructed of solid aluminum. It includes an integrated LED module that emits a cool, natural, or warm white light in multiple beam patterns, all selectable with a 5CCT switch. Can be rotated 180° and equipped with a glare shield for pinpoint accuracy. The landscape spotlight is great for gardens, tree uplighting, architectural lighting, and more.

UPGRADE

2200k 2700k 3000k 3500k 4000k

COLOR TEMPERATURE

180° SWIVEL

WET

ETL Intertek



Model	Size	Watts	Delivered lumens	CRI	Color °T	Voltage
LSP3-CCL	3"	10 W	500 lm	80	2200, 2700, 3000,	12 VAC
LSP4-CCL	4"	20 W	1000 lm		3500, 4000 K	

Specifications

Over 50,000 hours of service life
 12VAC input
 Switch-selectable CCT: 2200 K/2700 K/
 3000 K/3500 K/4000 K
 Easy-access CCT switch on
 back of spot
 Interchangeable 20°, 40°, and 90°
 beam angle lens
 180° swiveling head
 Cast aluminum construction
 Ground stake included
 Suitable for wet locations
 5-year warranty

Finish

● **BK** Black

Power supplies

LTRP-60-BK

60W, 120VAC 60Hz input
 12VAC output low-voltage transformer

LTR-300-BK

300W, 120VAC 60Hz input
 12/13/14/15VAC output low-voltage
 transformer

Note

Low-voltage transformer required.
 Sold separately.

Other color °T and finishes available, but
 may require MOQ's and longer lead times.
 Please contact your DALs representative
 for more information.

Accessories

LAN-ACC-MS

6 3/4" metal ground stake

LSP-EXT04

4" extension arm

LSP-WM

Spotlight wall mount adapters

LCBL-50-16

50 feet of 16 gauge low-voltage wiring

LCBL-100-16

100 feet of 16 gauge low-voltage wiring

LCBL-50-14

50 feet of 14 gauge low-voltage wiring

LCBL-100-14

100 feet of 14 gauge low-voltage wiring

LCBL-100-12

100 feet of 12 gauge low-voltage wiring

LCBL-200-12

200 feet of 12 gauge low-voltage wiring

LSP3-CCL

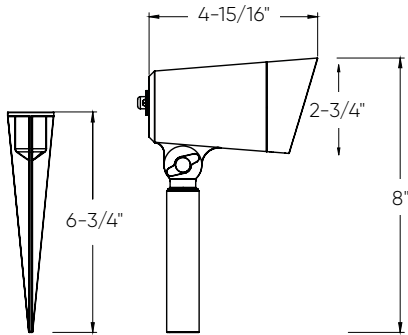

LSP4-CCL

